

REV C DRB16-102S*E-L018

REVISIONS			
SYM	DESCRIPTION	DATE	APPROVED
NC	RELEASED PER E.O. P17849	8-9-02	R.D.R.
A	REVISED PER E.O. P19236	5-10-06	R.D.R.
B	REVISED PER E.O. P19957	8-27-08	R.D.R.
C	REVISED PER E.O. P21520	12/18/12	Dm

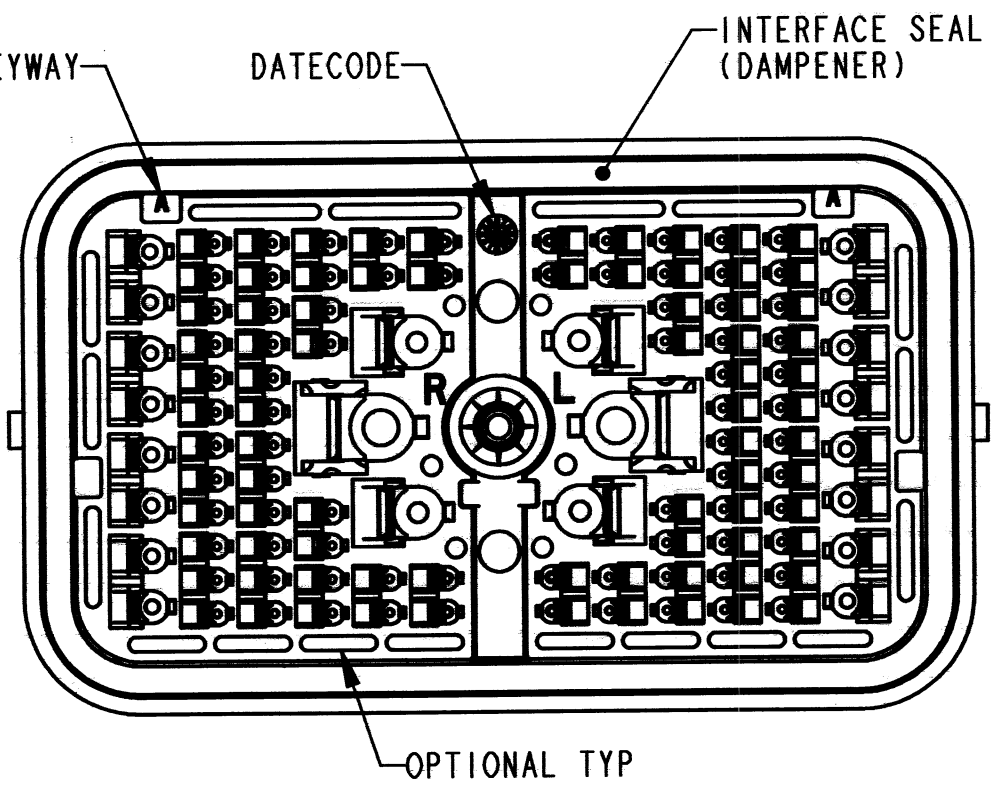
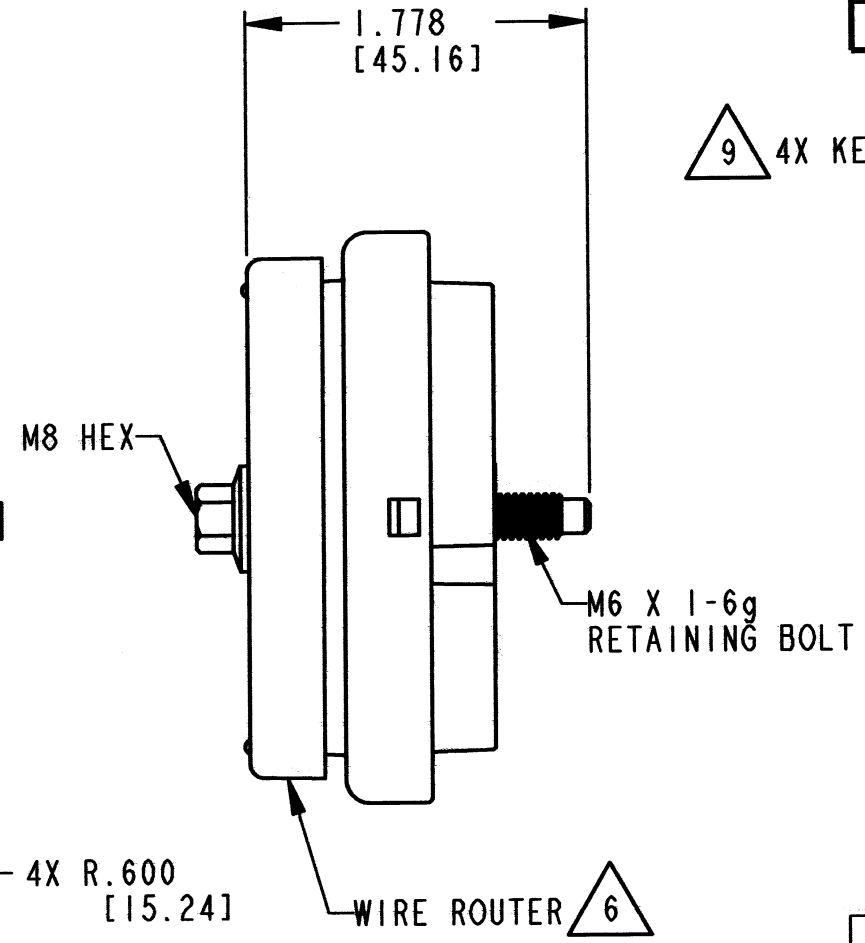
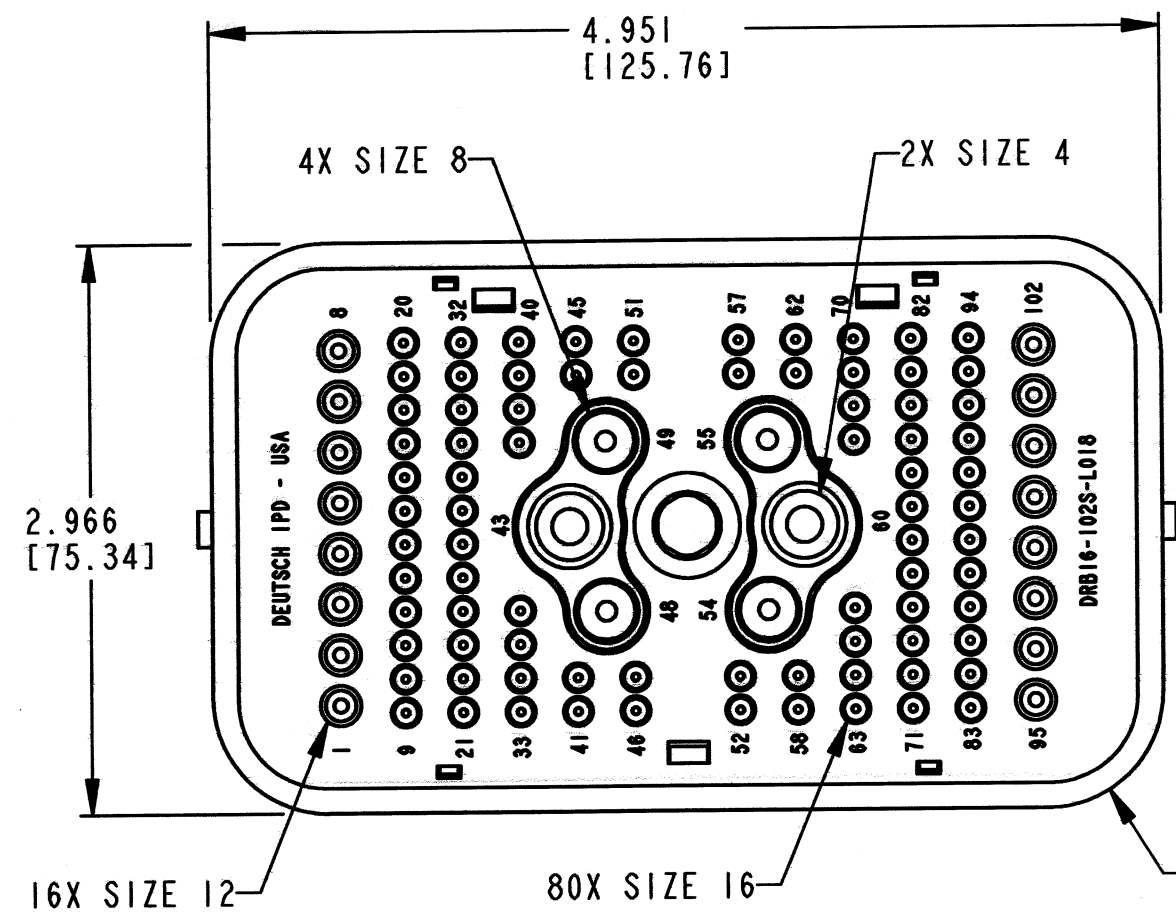

7. MATING TORQUE REQUIREMENT: 30-35 IN-LB [3.38-3.95NM]
- 6 WIRE ROUTER CAP IS INCLUDED WITH PLUG (-L018).
5. THIS PLUG MATES WITH DRB12-102P*(N)E-**** RECEPTACLE (* = A,B,C,D KEYS; **** = ALL MODIFICATIONS) CONSULT FACTORY FOR MODS.
- 4 FOR CONTACTS AND WIRE PERFORMANCE AND APPLICATION CHARACTERISTICS SEE INFORMATION DRAWING 0425-015-0000.
3. ITEMS SOLD SEPARATELY: SECONDARY LOCKS: WB-51S*R AND WB-51S*L INTERFACE FLANGE: DRBF-1*
2. DIMENSION TOLERANCE: ±.025 [.64].
1. DIMENSIONS ARE IN INCHES [mm].

9. SEE SHEET 2 FOR OTHER KEY ARRANGEMENTS.
- 8 MATERIAL - PLUG: PLASTIC
SEAL/GROMMET: RUBBER
CLIP: STEEL
BOLT: STEEL WITH SILVER PLATE, BOLT MAY TARNISH.

CONTACT SIZE	MIN. INSUL. O.D. [mm]	MAX. INSUL. O.D. [mm]	WIRE RANGE [mm ²] REF ONLY
4	.261 [6.629]	.292 [7.417]	6 AWG [13.0]
8	.135 [3.429]	.220 [5.588]	8-10 AWG [8.0-5.0]
12	.097 [2.464]	.158 [4.013]	12-14 AWG [3.0-2.0]
16	.053 [1.346]	.120 [3.048]	14-20 AWG [2.0-0.5]

NOTES:

SIGNATURE & DATE	
DR	J. APOSTOL 13DEC2012
CHK	Paul M. Gal 12/18/12
PE	Paul M. Gal 12/17/12
APPD	D. Meyx 12/18/12
SCALE	NONE WT 232g

PLUG, 102 CONTACTS
KEYS: A, B, C, D
"E" SEAL; COLOR: BLACK
-L018 MOD
DRB SERIES
ENVELOPE

EP 046 MATL. CODE

3850 INDUSTRIAL AVE.
HEMET, CA 92545

DEUTSCH
INDUSTRIAL

B DRB16-102S*E-L018

DWG SIZE CODE 11139 SHEET 1 OF 2

REV
C DRB16-102S*E-L018

REVISIONS			
SYM	DESCRIPTION	DATE	APPROVED
C	SEE SHEET 1	12/18/12	Dm

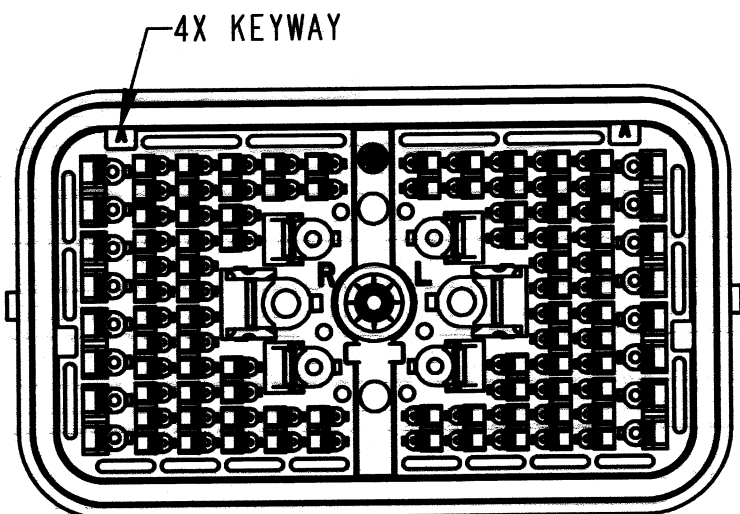

DRB16-102SAE-L018
KEY: A

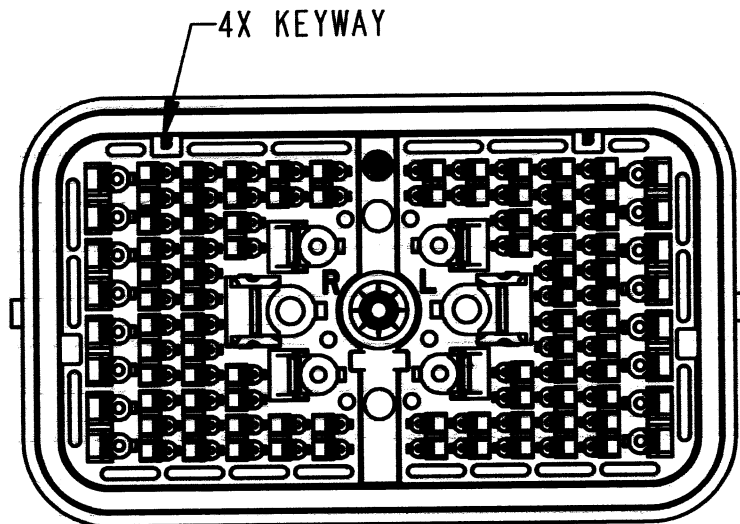

DRB16-102SBE-L018
KEY: B

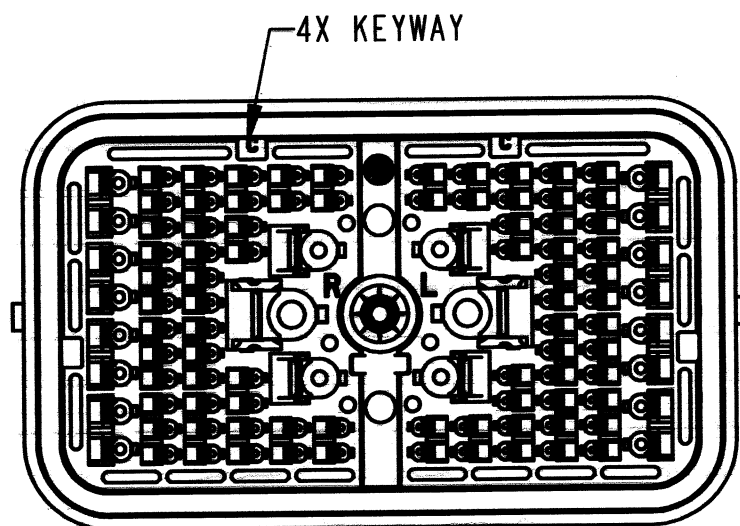

DRB16-102SCE-L018
KEY: C

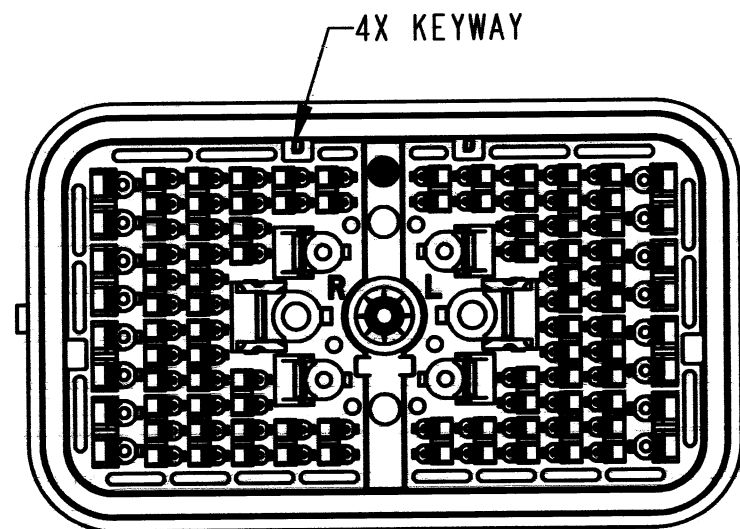

DRB16-102SDE-L018
KEY: D

NOTES:

SIGNATURE & DATE	
DR	J. APOSTOL 13DEC2012
CHK	Paula M. Land 12/17/12
PE	Paula M. Land 12/17/12
APPD	Dmery 12/17/12
SCALE	NONE WTSEE SHEET 1

PLUG, 102 CONTACTS
KEYS: A, B, C, D
"E" SEAL; COLOR: BLACK
-L018 MOD
DRB SERIES

ENVELOPE

EP 046	MATL. CODE
 3850 INDUSTRIAL AVE. HEMET, CA 92545	
B DRB16-102S*E-L018	
DWG SIZE	CODE 11139 SHEET 2 OF 2

